

RoHS

REVISION DATE

ITEM	DESCRIPTION	DATE
A	Issue	

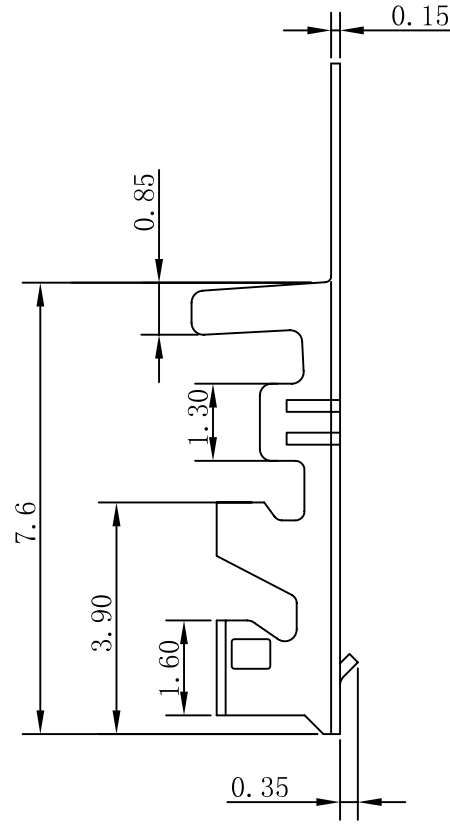
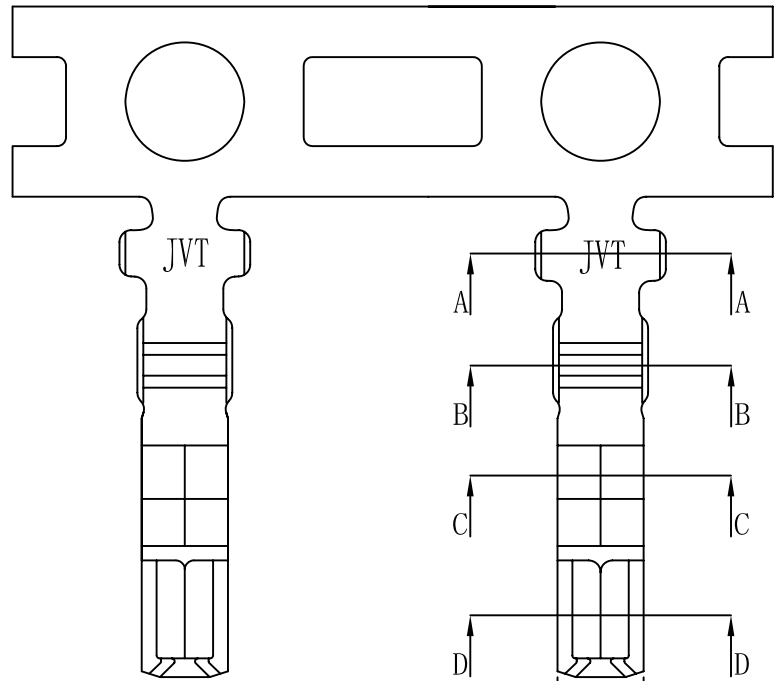

■ TERMINAL

- Part No. : JVT2038TP-XXX
- Material: Phosphor Bronze
- Thickness: 0.15mm
- Finish: Tin-plated
- Applicable wires: AWG# 22~28
- Q' ty: 10,000 pcs/reel

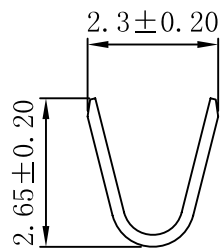
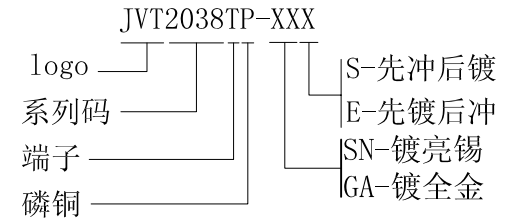

SECTION:A-A

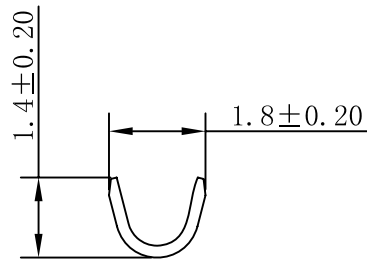

SECTION:B-B

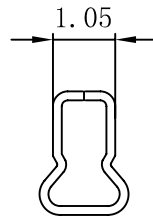

SECTION:C-C

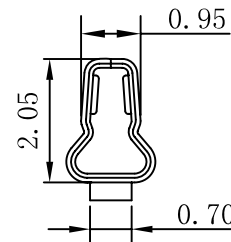

SECTION:D-D

投影 (PROJECT)		公差 (TOLERANCE)	
单位 (UNIT)	mm	0	±0.50
比例 (SCALE)	FIT	0.0	±0.30
版本 (EDITION)	A	0.00	±0.20
日期 (DATE)	2013 10 14	0.000	±0.10

东莞市乔业电子有限公司
DONG GUAN CHYAO YEE (JVT) CONNECTORS CO., LTD.

绘图 (DRAWN)	TONY	料号 (PART NO)	JVT2038TP-XXX	页次 (PAGE)	
审核 (CHECKED)	CHEN	图号 (DRAW NO)	031-2038-01		1/1
核准 (APPROVE)		品名 (NAME)	PAD 2.0mm TER		